

Go handmade
quality design in a unique style

CROCHET & KNITTING

Safe handling and assembling

CONCERNING:

- The baby bed
- The pram
- Buttons and strings
- Pacifier chains
- Play area on the floor
- Activity figures
- Animals and sensory toys
- Tow carts
- Knitting/crochet tightness
- Our experience
- EN 71





INTRODUCTION

Many people have a great passion for the world of possibilities offered by handy crafts and quality materials – they appreciate the joy of crafting and of gifting the finished product to others. To be the lucky recipient of something made with lots of love, created with knitting pins or crochet hooks, well, that is memorable. We know that for many, knitting and crocheting is a kind of therapy – immersing yourself in a good pattern, and watching it all take shape, adds quality to your life.

When crafting for the little ones, it needs to be done right in order for the products to be safe. That is why we recommend homemade products to be created and assembled safely.

With this guide, draw attention to the safety measures to keep in mind when crafting toys and cosy handiwork for children under the age of three. The guide is not exhaustive, but a solid foundation for those who do it themselves ... and want to do it safely ...



THE PRAM

- HANGING TOYS IN THE PRAM
 - GARLANDS
 - RINGS OR CLIPS TO HOLD THE GARLAND AND TOY
-

- A small animal with a short string and a ring will be fun for a child to look at, and it can be taken down and given to the child. The ring should be more than 5 cm in diameter. Small suspender clips must not be used with this toy. Children who cannot yet sit up by themselves may have a toy forced down their throat if they roll over on their stomach with it in their mouth. Therefore, it is important that the ring is more than 5 cm in diameter, rather than an ordinary suspender or pacifier string clip.
- A tightly mounted garland across the carrycot is fun for the baby to look at. The child is not supposed to pull on the garland or the figures on it. Figures on a garland should hang on the string itself. The garland should not hang loosely above the child. The child should not be handed the garland to play with. Remove the garland as soon as the child is able to get up on their hands and knees. Avoid making long strings that the child can reach. Long cords are generally problematic in toys, but for ready-made toys an exception has been made for garlands hanging across the pram. This requires that the toy is removed once the child starts to get up. Otherwise, there is a risk that they could fall over the string with their head/neck.
- The garland/hanging toy can be attached with clips or rings. It can also be tied to the bows of the canopy. Children should not be handed the clips to play while they are too small to sit up on their own.

*Sensory
Duck*

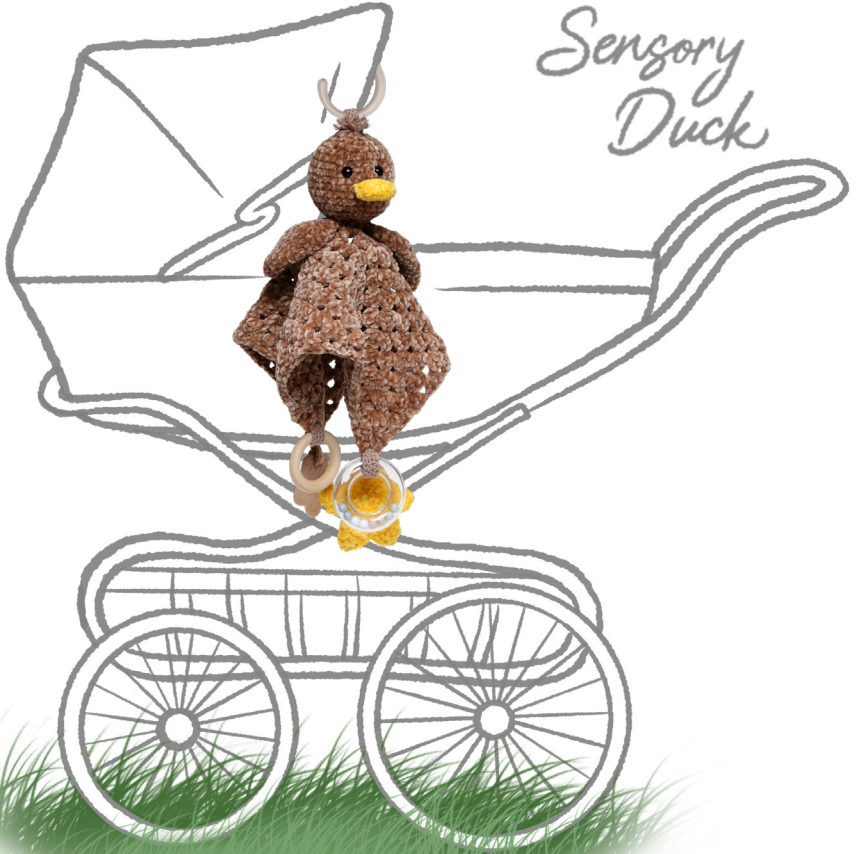

*Sweetheart
Bunny*

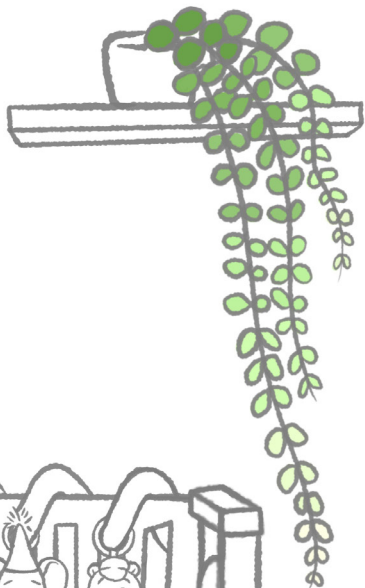



THE BABY BED

- TOYS IN OR ON THE BED
- GARLANDS ACROSS THE BED
- BABY MOBILES HANGING ABOVE THE BED

-
- Toys attached to the bed should not have strings longer than a maximum of 22 cm. There should be nothing at the end of the cord that could get stuck and tighten around the neck. Children should not have toys in the bed while unsupervised for longer periods. For instance, there is a risk that toys and other objects could be used for support, making it easier for the child to get out of the bed. It is important to know that your child is sleeping safely in bed while unsupervised for many hours.
 - Mobiles hanging above the bed should be hung out of reach and removed as soon as the child starts to get up on knees and elbows. Mobiles often have toys hanging from strings, which can pose a risk if the child suddenly grabs them and pulls them into the bed.



ANIMALS AND SENSORY TOYS

- ASSEMBLING OF ARMS, LEGS AND OTHER PARTS
- SENSORY OBJECTS INSIDE THE ANIMAL
- ASSEMBLING OF EYES
- MUSIC BOX WITH INTERNAL STRING
- FILLING

-
- A tightly knitted/crocheted exterior is important to prevent the child from accessing the filling. In the same way, arms, legs etc. must be sewn on tightly to avoid any holes or openings into the filling. Large amounts of filling pulled from the animal could get stuck in the child's throat.
 - Sensory objects should be sewn tightly and behind some fabric to prevent them from being pulled apart. Avoid sewing on anything crackly where the perforation of sewing could cause damages to the crackly paper, allowing it to be pulled off into smaller pieces.
 - A music box with string can easily fit into the animals. The max. length of the string is 22 cm when fully extended. Do not hang a ball at the end of the string, as even large balls (up to 4.5 cm in diameter) can be problematic if they get inside the child's mouth - even if they are hanging on a string.
 - Polyester fibre filling is particularly suitable for toys as it is soft and airy. It can also be packed to obtain firmness - and it can be both washed and dried. You can also put the filling inside a small fabric bag before stuffing it into the animal as an added measure of safety. Avoid putting small, sharp, or pointed parts inside with the filling - or forgetting a needle inside.



Rattlecellophane
in ears



Squeezer in paws
25 x 14 mm



TPE figure

Wooden ring
55 mm



Rattlebox in legs
22 mm

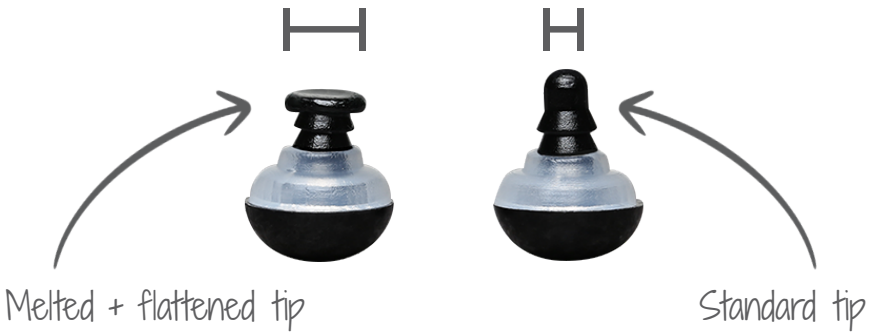
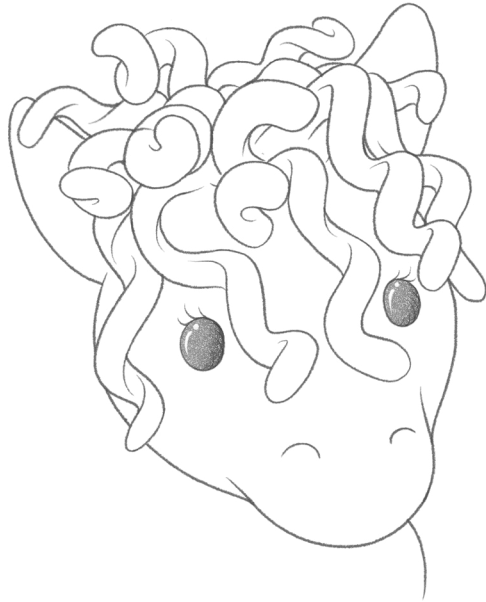



ASSEMBLING OF EYES

- ASSEMBLING OF EYES
 - EXTRA FIRM ASSEMBLING
-

- Safety eyes can be attached to a knitted, crocheted, or regular woven textile. Always remember to test the assembled product by pulling on the eyes from the outside. They must be able to withstand a strong pull, using your fingers/nails to be safe for a child tugging on them.
- It is important that the stopper is attached close to the back of the eye – at the bottom of the stem. If you have used thick yarn to knit/crochet, it can be difficult to get the stopper to lock far enough down the stem. The crocheted/knitted material takes up more space than what is intended between the back of the eye and the stopper. In this case, the stopper will not be able to fit tightly enough. You can strengthen the stopper's hold on the eye/stem by following the directions in our YouTube video. The video shows how to (easily) melt the end of the stalk a little – and then press it. This way, the end piece is wider than the stopper hole and the attachment is strengthened.
- We recommend that you always perform a safety check of anything that you assemble. Follow our YouTube video for further directions



BABY THAT CANNOT SIT UP

- SAFETY MEASUREMENTS FOR SENSORY PRODUCTS
 - HARD PARTS VS. SOFT PARTS
-

- Template A is a measuring tool used in testing laboratories to inspect, in particular, finished toy products. The oval template A ensures that 'stiff' (solid) parts of a toy for children who are too small to sit up unsupported cannot enter the throat and cause pressure. This can induce vomiting and trouble breathing if the baby lies on their stomach with part of the toy in their mouth. They're unable to hold their head up and this can cause part of the toy to be pushed into their throat if the toy is long and narrow.
- **This requirement – and this test – therefore apply to:**
 - 1. Toys for children that cannot sit up unsupported, and**
 - 2. Stiff parts, as soft-lined parts cannot press into the throat.**

Hard (solid) parts of a toy for children that are too small to sit up unsupported mustn't be able to reach below the bottom of template A. This way, the toy can't enter the throat and cause pressure if the child rolls over on their stomach with the toy/part of the toy in their mouth. This applies to, for instance, a teether or a rattle, while the requirement doesn't apply to soft parts.

However, a hard part inside a soft part would be at risk of causing the same safety issue if the part that covers the hard part, i.e., a rattle box, is small enough to slide into the hole in template A.



TEMPLATE A

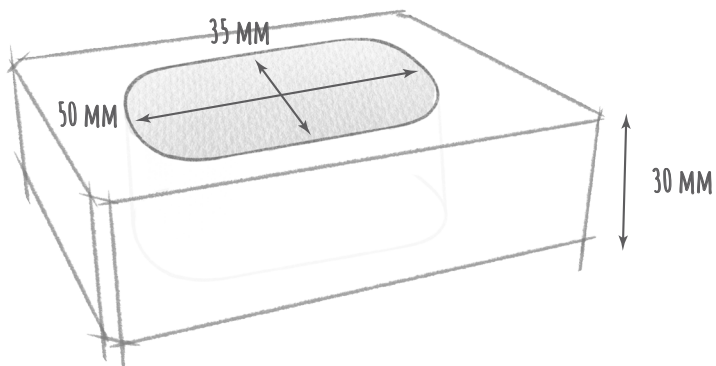

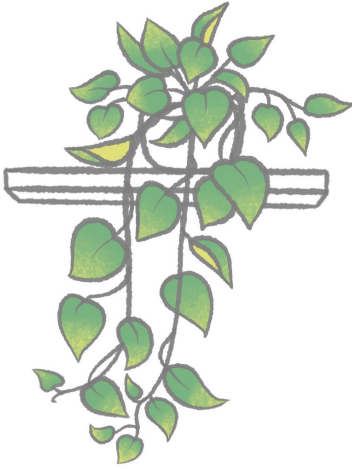

*Sensory
Bunny*





YARN AND HANDIWORK

- CROCHET/KNITTING TIGHTNESS
 - KNOTS AND LOOPS
-

- Make sure to knit and crochet the material tightly, as it will help to keep any filling inside the stuffed animal and improve its durability, especially if you, for instance, attach safety eyes or sew something else onto it. Avoid loose crocheting and knitting, as a child may get their fingers inside and pull at the filling... which is then likely to end up in their mouth. Large amounts of filling entering the mouth can clump together, get stuck, and make it difficult for the child to breathe.
- Fixed loops should have a maximum circumference of approx. 38 cm. Knots are allowed on short strings under 22 cm, and they should be as small as possible in relation to the thickness of the string. Never make a loop with a circumference of more than 38 cm (measured while pulling). When a fixed loop (tied in advance and fastened at the same point) is less than 38 cm, it should not be able to go over the child's head and thus pose a risk. Knots that make up small parts (beads, rings etc.), could cause a string to get stuck - and a string that gets stuck can pose a risk to a child who, for instance, rolls around with the toy close to their head and throat.



ACTIVITY FIGURES AND DICES

- LOOSE PARTS
- BITING ELEMENTS

-
- Parts that can be detached from a toy or parts that hang loosely must be large enough that they cannot fit into the "toy tester". The toy tester is a cylinder with an opening of approx. 32 mm, and parts that cannot fit all the way into it are generally large enough to not present any dangers to children under the age of three. However, small balls must be at least 4.5 cm in diameter to be considered safe. Do not put balls with a diameter of less than 4.5 cm on a string for children under the age of three.
 - Biting elements are difficult to make by yourself, and you should purchase those that already have the shape and size that are considered safe (as if they were ready-made toys). Elements longer than 30 mm should always be avoided unless they are also quite wide. Biting elements will often be used by children who cannot sit up unaided, and if they roll over on their stomachs with a wrongly-sized biting element in their mouth, it could run the risk of being forced into the child's throat.

Sensory Cubes



TOY TESTER - SMALL PARTS

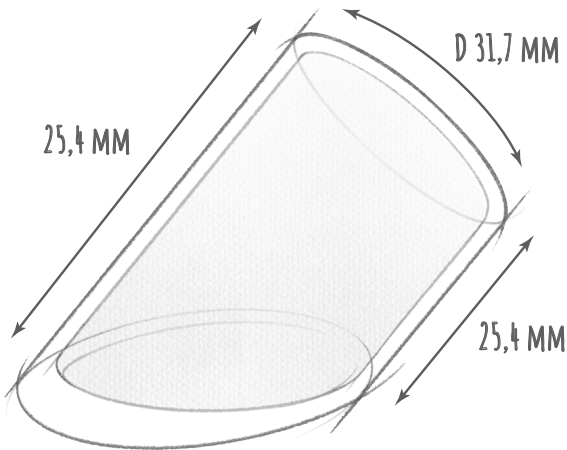

CLOTHES WITH BUTTONS AND CORDS

- STRINGS IN HOODIES
 - STRINGS IN BEANIES AND BONNETS
 - SCARVES
 - NO LOOSE ENDS
-

- Strings in hoodies for children up to 13 years old are not safe and should be avoided, according to the safety standard (EN 14682) for strings in children's clothing sold in the EU. The standard is based on the risk of strings in clothing for both small and large children getting caught.
- It is generally important to make sure there are no parts in children's clothing that could flow too loosely and thus get caught – for instance, in train doors or playground equipment.
- Scarves are inherently dangerous, for the above reasons, for small children in particular. If the end of a scarf gets caught while a child is climbing trees, for instance, it is easy to imagine the danger. Scarves should therefore be avoided or used cautiously.
- The standard does not include beanies with strings, however – such as a bonnet or baby hat – so it is our recommendation to make these with strings that are as short as possible while still being functional. You should also pay attention to other beanie features or details that could get caught. An example here would be a beanie featuring a pompom and two tie strings under the chin. The pompom could get stuck while the two strings pressed on the neck of the child, posing a choking hazard. If you want to include tie strings and a pompom in a beanie, one option is to attach the pompom to the beanie with a snap button. This way, the pompom will be detached from the beanie if it gets caught in a tree or in other similar hazards.

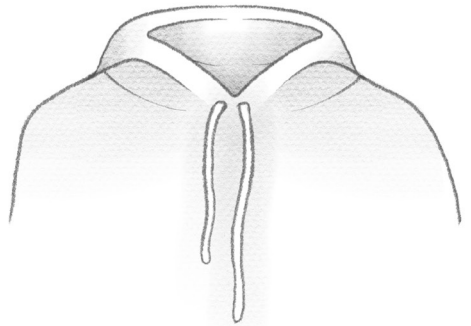
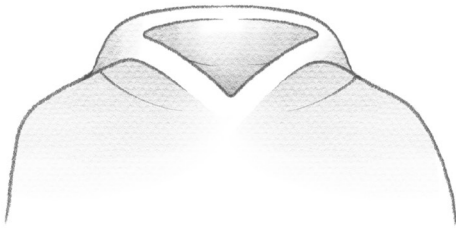
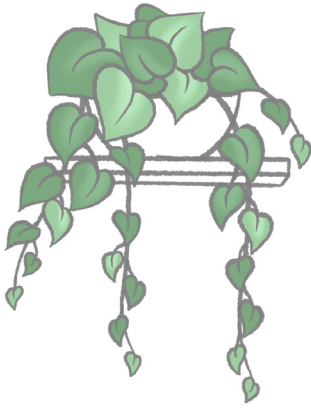

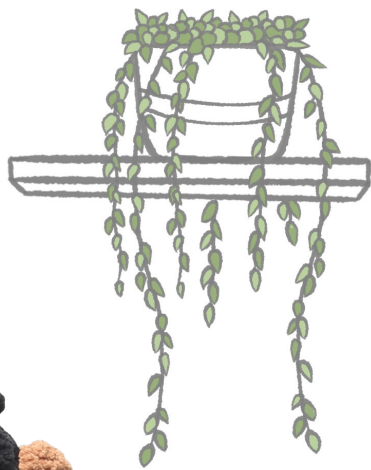



TOW CARTS

- LENGTH OF STRING
 - RING/BALL/OTHER OBJECT ON THE STRING
-

- For pull-along toys, such as the classic elephant on wheels, a pull cord up to 80 cm long can be attached. However, remember that no objects can be attached at the end of the string. There cannot be any objects at the end of a long string: no knots, loops or objects that could get stuck. For instance, if the child is lying down and playing with the pull-cart, it could get stuck around the child's neck. In ready-made toys, pull-along cords may be up to 80 cm long, provided there are no knots, loops or object at the end of the string. This is an exception to the general string requirements, but otherwise this type of toy would be difficult for the child to play with.
- No rings, balls or other objects can be attached to a long string - this applies to the entire length of the string.

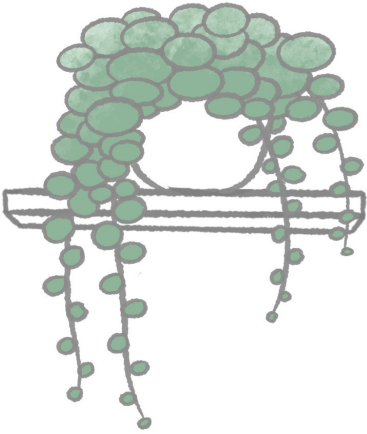



ACTIVITY AREA ON THE FLOOR

- ACTIVITY STAND
- PLAY BLANKET

-
- The legs of an activity stand should have a diameter/cross-section of at least 37 mm, and it is important that it is stable – especially if it has substantial weight. Figures can be hung on short strings, but preferably so the child can touch them. The strings used to attach the toys should be as short as possible. Optimally, the combination of short strings and the placement of the figures is made in a way that prevents the figures from touching each other. If the child can only barely reach the figures, there is less risk of the stand tipping over. The short strings will prevent the figures from getting tangled around the child's neck.
 - The play blanket can feature strings shorter than 22 cm, and if it is a single string, you can put a block or ring at the end of it. Do not put a ball at the end of a string. If there are several strings, there should be no attachments at the end of them. Balls at the end of strings can be dangerous if they enter the child's throat. Balls with a diameter of more than 4.5 cm are okay to use.



PACIFIER CHAINS AND SUSPENDER CLIPS

- WITH SOOTHER
- VENTILATION HOLES
- WITH KNITTED/CROCHETED FIGURE

-
- If you attach a suspender clip to a crochet pacifier chain, make sure that the chain is no longer than 22cm when pulled. This should be the full length from where the cord passes through the loop on the clip, down to and including the end of the soother attachment. It is a good idea to make sure that the chain is not pulled further down than 22cm when in use. We recommend that you always crochet tightly when making chains for soothers and/or to make a shorter chain from the start.
 - A suspender clip used for a pacifier chain, i.e., with a soother attached to the chain, must have ventilation holes. The holes in a soother chain's clothing attachment should be at least D5.05 mm if there are two holes and at least D4.12 mm if there are three holes. Both options meet the requirement of at least 40 mm² ventilated area in the suspender clip. The holes must not be larger than 5.5mm in diameter, as the child's fingers could get stuck.

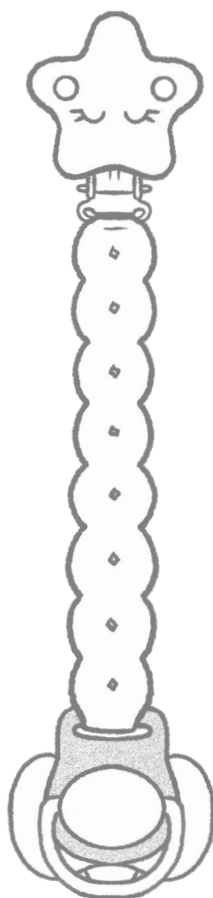
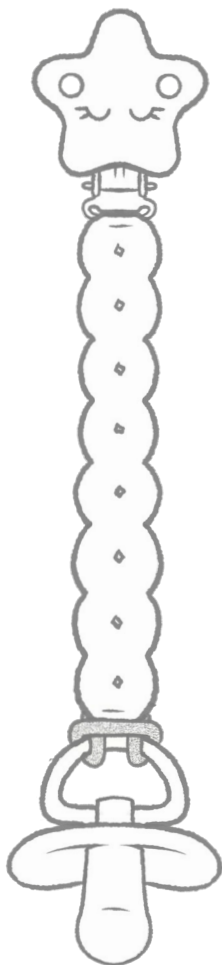

O-RING

O-RING
WITH ADAPTER



- Do not use suspender clips to attach a crochet figure/animal at the end if it will be given to a child who cannot sit up on their own.



OUR EXPERIENCE

- MISTAKES
 - AUTHORITIES
-

At Go handmade, learning to understand and incorporate all product requirements has been a long journey. We've made mistakes on the way, but it is these mistakes, challenges and, frankly, frustrations about how difficult it can be that have led us to make this guide.

It was created by Go handmade with professional assistance from Consumer Lab Denmark.

Authorities offer only limited information to our DIY world, and though there are testing institutes and safety standards, many parts/products, such as crochet toys, are made up of multiple parts – thus it becomes necessary to assess product safety.

This can be difficult when the official safety requirements are not known.

Here's an example. There is wide usage of wooden figures in crochet rattles. For the finished rattle to be safe, however, it must pass the form (A) test mentioned on page 12 – hardly anyone is aware of this.

The market offers many wooden figures that by themselves – not attached to a rattle – wouldn't be able to pass the form (A) test and also wouldn't be safe if attached incorrectly to the homemade crochet rattle. However, when the figure and parts are combined correctly, the toy will be of a shape and size that passes the test.

TEMPLATE A

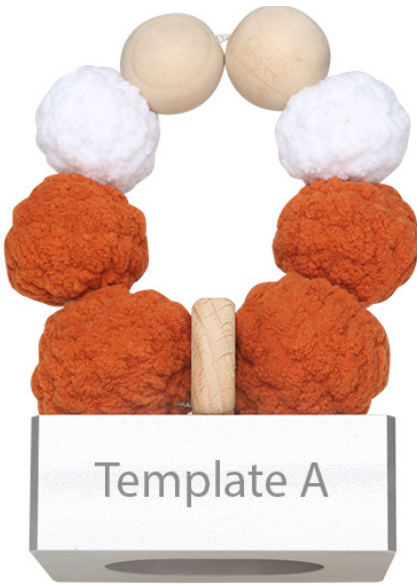
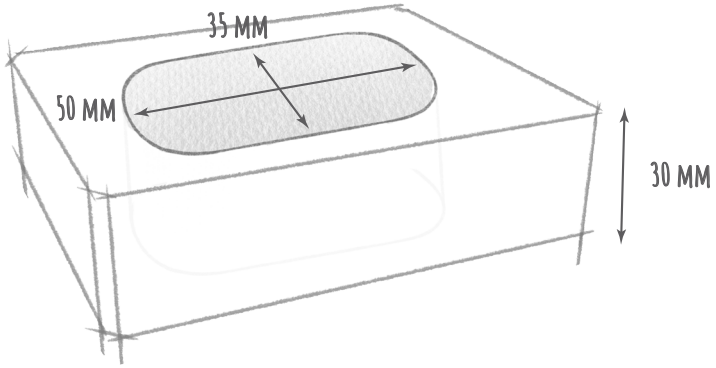

EN 71

- EU AND GLOBAL STANDARDS
 - TEST REPORTS
 - 'HOW WE WORK'
-

Safety standards set requirements for a product and are typically made in the EU – but there are global standards as well. This means that there are official agreements on product safety in terms of the shape, strength, and size of various parts. According to these standards, a product must meet a numbered standard, such as EN 71.

EN 71 is a series of safety standards that finished toys must meet in order to be presumed safe for children to play with. It therefore also applies to individual parts used when crocheting, knitting, or stitching together a DIY toy.

Test reports on various tests of parts and materials provide documentation of safe compliance with the requirements. Often, it is the materials that are chemically tested, not their shape that is examined. In many cases, it is therefore not relevant to have a test report for each individual part, just as the test report must be viewed as part of a larger puzzle where manufacturers must show compliance with the requirements.

Read more about Go handmade's work with suppliers, chemistry, and safety requirements etc. in the document 'How we work' on our website.



Rattle box
in leg

INSIDE A SENSORY TEDDY

- || A child will not come in contact with a component, as a rattle box, because it's inside the leg of a sensory teddy. Because the child can't come in contact with a component, which is closed in, certain requirements for chemistry are not relevant for that kind of products.

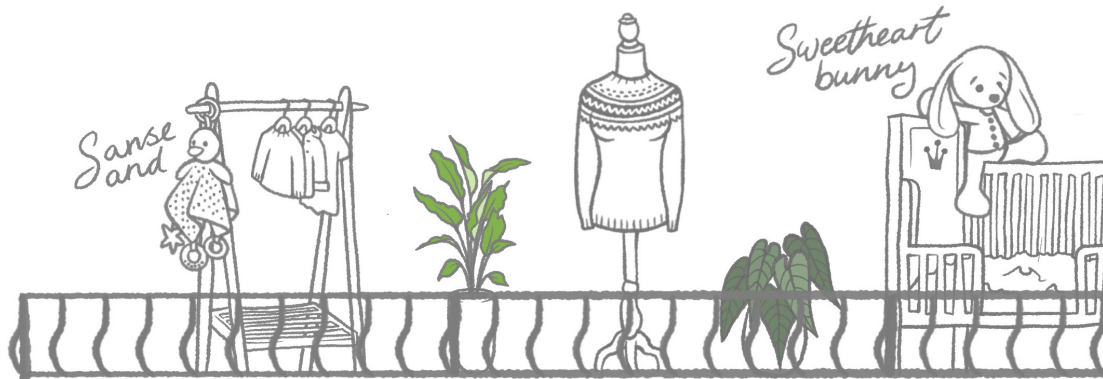

VIDEO PRESENTATION

Extra strength - Checking eyes - Embroider eyes and noses - R



EXTRA STRENGTH - SAFETY EYES



It is possible to strengthen the stopper's hold on the stem by doing the same as in our video. The video shows how the end of the stem can (easily) be slightly melted - then flattened. By doing this, the end of the stem becomes bigger than the hole in the stopper. This creates a strengthening of the eye.

CHECKING THE SAFETY EYES



We advice, that the safety eyes always gets controlled. See the YouTube video to see how.

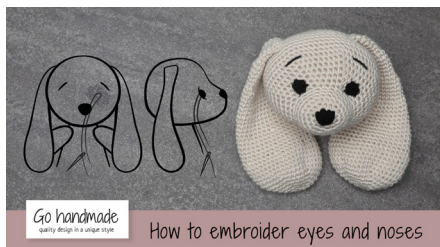

HOW TO EMBROIDER EYES AND NOSES



Tip for perfect eyes:

Cut approximately 25 cm of yarn, insert the needle under the chin and up at the inside of the eye. Sew over a stitch and insert the needle down to the chin. Tighten the yarn to form the hollow around the eye.



ONS ON YOUTUBE

Rattle cellophane - Sensory Bunny - Assembling Teddy Basserne



RATTLE CELLOPHANE



Rattle Cellophane can make a crackling sound that small children and babies love. You can for example add it in the ears or body of a homemade teddy.

SENSORY BUNNY



An activity toy that sharpens baby's sensory abilities. The sound features make it fun and interesting for the baby to touch and play with - right up to the age of 1 year - maybe even longer.



ASSEMBLY OF TEDDY BASSERNE



Tips for perfect and easy assembly of Teddy Basserne.



FOLLOW US



Go handmade
quality design in a unique style